

CM1218

Low Capacitance Transient Voltage Suppressors / ESD Protectors

Description

The CM1218 family of devices features transient voltage suppressor arrays that provide a very high level of protection for sensitive electronic components which may be subjected to electrostatic discharge (ESD).

All pins of the CM1218 are rated to withstand ± 15 kV ESD pulses using the IEC 61000-4-2 contact discharge method. Using the MIL-STD-883D (Method 3015) specification for Human Body Model (HBM) ESD, all pins are protected from contact discharges of greater than ± 30 kV.

The CM1218 is supplied in a number of compact, surface mount packages depending on the channel configuration desired.

Features

- Low I/O Capacitance at 7 pF Typical
- Two, Three, Four or Five Channels of ESD Protection
- In-system ESD Protection to ± 15 kV Contact Discharge, per the IEC 61000-4-2 International Standard
- Compact SMT Package Saves Board Space and Facilitates Layout in Space-critical Applications
- Each I/O Pin Can Withstand over 1000 ESD Strikes
- These are Pb-Free Devices

Applications

- High-speed Consumer Electronic Ports
- ESD Protection of PC Ports, Including USB Ports, Serial Ports, Parallel Ports, IEEE1394 Ports, Docking Ports, Proprietary Ports, etc.
- Protection of Interface Ports or IC Pins which are Exposed to High ESD Levels



ON Semiconductor®

<http://onsemi.com>



SOT23-3
SO SUFFIX
CASE 419AH



SOT23-5
SO SUFFIX
CASE 527AH



SOT23-6
SO SUFFIX
CASE 527AJ



SOT143
SR SUFFIX
CASE 527AF



SOT-553
SE SUFFIX
CASE 463B



SOT-563
SE SUFFIX
CASE 463A



SC70-3
S7 SUFFIX
CASE 419AB



SC70-5
S7 SUFFIX
CASE 419AC



SC70-6
S7 SUFFIX
CASE 419AD

BLOCK DIAGRAMS

(see page 2)

MARKING DIAGRAM

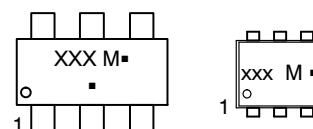

XXX = Specific Device Code
M = Date Code
■ = Pb-Free Package

(Note: Microdot may be in either location)

ORDERING INFORMATION

(see the last page of this document)

CM1218

BLOCK DIAGRAMS

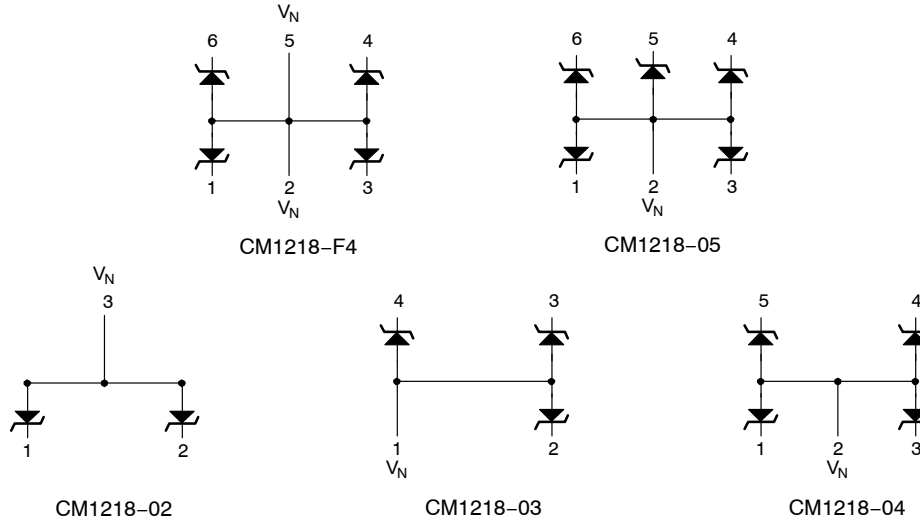

PACKAGE / PINOUT DIAGRAMS & PIN DESCRIPTIONS

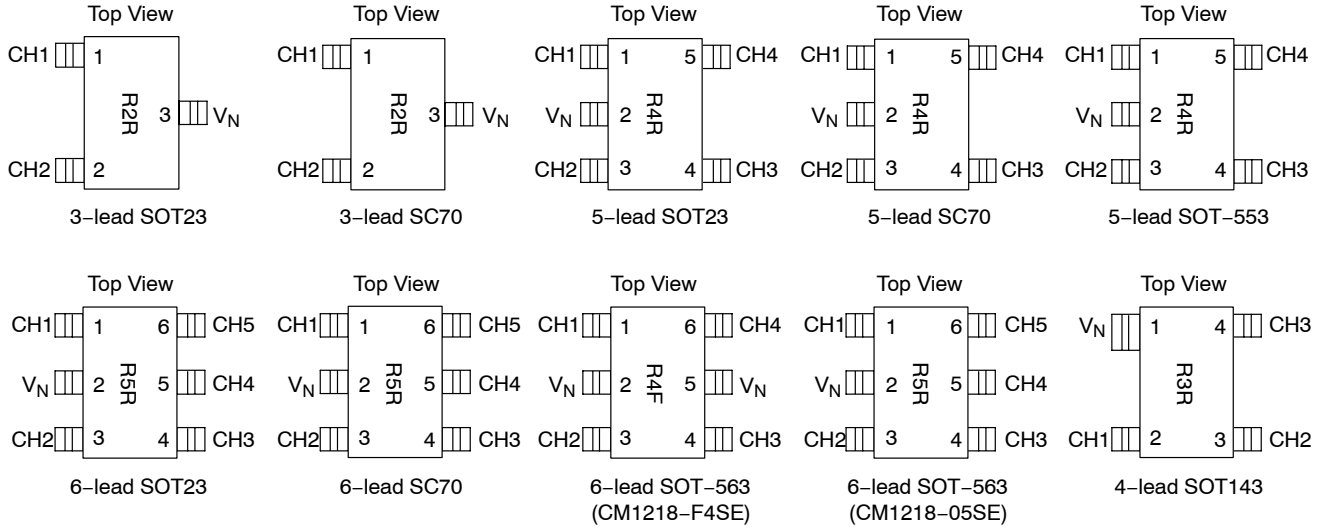

- Rxx = Specific Device Code
- CHx = The Cathode of the Respective TVS Diode, which should be connected to the node requiring transient voltage protection
- V_N = The Anode of the TVS Diodes

Note: SOT23, SC70 and SOT143 and packages may differ in size. These drawings are not to scale.

Specifications

Table 1. ABSOLUTE MAXIMUM RATINGS

Parameter	Rating	Units
Storage Temperature Range	-65 to +150	°C
Package Power Dissipation SC70 SOT23-3, SOT23-5, SOT23-6, SOT143 SOT-553, SOT-563	0.2 0.225 0.15	W

Stresses exceeding Maximum Ratings may damage the device. Maximum Ratings are stress ratings only. Functional operation above the Recommended Operating Conditions is not implied. Extended exposure to stresses above the Recommended Operating Conditions may affect device reliability.

Table 2. STANDARD OPERATING CONDITIONS

Parameter	Rating	Units
Operating Temperature	-40 to +85	°C

Table 3. ELECTRICAL OPERATING CHARACTERISTICS (Note 1)

Symbol	Parameter	Conditions	Min	Typ	Max	Units
C _{IN}	Channel Input Capacitance	T _A = 25°C, 2.5 VDC, 1 MHz		7		pF
ΔC _{IN}	Differential Channel I/O to GND Capacitance	T _A = 25°C, 2.5 VDC, 1 MHz		0.19		pF
V _{RSO}	Reverse Stand-off Voltage	I _R = 10 μA, T _A = 25°C	5.5			V
		I _R = 1 mA, T _A = 25°C	6.1			V
I _{LEAK}	Leakage Current	V _{IN} = 5.0 VDC, T _A = 25°C			1	μA
V _{SIG}	Small Signal Clamp Voltage Positive Clamp Negative Clamp	I = 10 mA, T _A = 25°C		6.8		V
		I = -10 mA, T _A = 25°C		-0.8		V
V _{ESD}	ESD Withstand Voltage Contact Discharge per IEC 61000-4-2 standard Human Body Model, MIL-STD-883, Method 3015	T _A = 25°C; Notes 3 & 4	±15			kV
		T _A = 25°C; Notes 2 & 4	±30			kV
R _D	Diode Dynamic Resistance Forward Conduction Reverse Conduction	T _A = 25°C; Note 2				Ω
				1.1		Ω
				2.7		Ω

- 1 All parameters specified at T_A = -40°C to +85°C unless otherwise noted.
- 2 Human Body Model per MIL-STD-883, Method 3015, C_{Discharge} = 100 pF, R_{Discharge} = 1.5 KΩ, V_N grounded.
- 3 Standard IEC 61000-4-2 with C_{Discharge} = 150 pF, R_{Discharge} = 330 Ω, V_N grounded.
- 4 These measurements performed with no external capacitor on CH_X.

Performance Information

Diode Capacitance

Typical diode capacitance with respect to positive TVS cathode voltage (reverse voltage across the diode) is given in Figure 1. Diode Capacitance vs. Reverse Voltage.

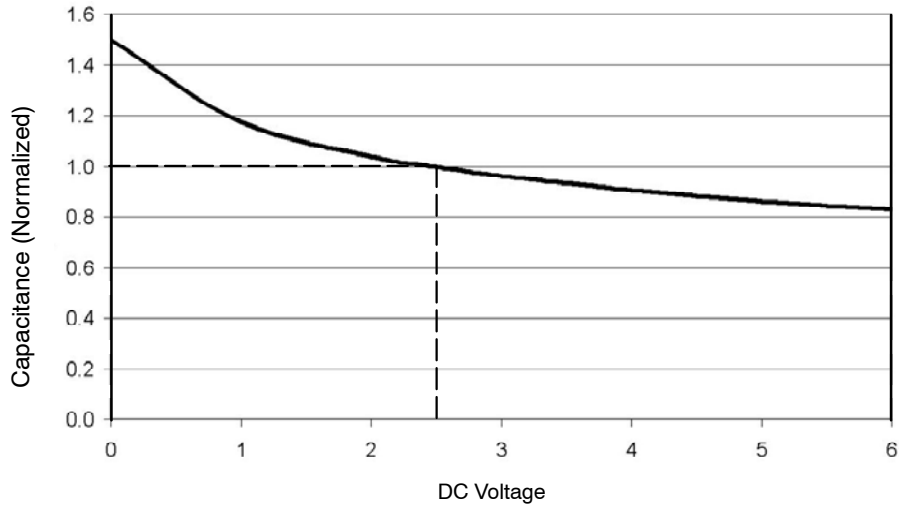
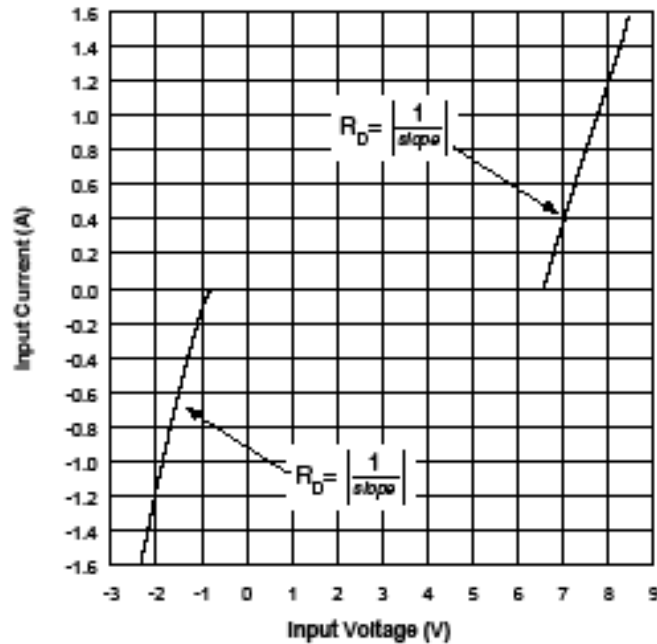

Figure 1. Diode Capacitance vs. Reverse Voltage

Typical High Current Diode Characteristics

Measurements are made in pulsed mode with a nominal pulse width of 0.7 ms.

Typical Input VI Characteristics
(Pulse-mode measurements, pulse width = 0.7ms nominal)



CM1218

Mechanical Details

The CM1218 devices are supplied in the following packages: SOT23-3, SOT23-5, SOT23-6, SOT143, SOT553, SOT563, SC70-3, SC70-5, and SC70-6.

Table 4. TAPE AND REEL SPECIFICATIONS

Part Number	Package	Package Size (mm)	Pocket Size (mm) $B_0 \times A_0 \times K_0$	Tape Width W	Reel Diameter	Qty per Reel	P_0	P_1
CM1218-02SO	SOT23-3	2.92 X 2.37 X 1.01	2.77 X 3.15 X 1.22	8 mm	178 mm (7")	3000	4 mm	4 mm
CM1218-04SO	SOT23-5	2.90 X 2.80 X 1.45	3.20 X 3.20 X 1.40	8 mm	178 mm (7")	3000	4 mm	4 mm
CM1218-05SO	SOT23-6	2.90 X 2.80 X 1.45	3.20 X 3.20 X 1.40	8 mm	178 mm (7")	3000	4 mm	4 mm
CM1218-03SR	SOT143	2.92 X 2.37 X 1.01	2.60 X 3.15 X 1.20	8 mm	178 mm (7")	3000	4 mm	4 mm
CM1218-04SE	SOT553	1.60 X 1.60 X 0.55	1.78 X 1.78 X 0.69	8 mm	178 mm (7")	5000	4 mm	4 mm
CM1218-F4SE CM1218-05SE	SOT563	1.60 X 1.60 X 0.55	1.78 X 1.78 X 0.69	8 mm	178 mm (7")	5000	4 mm	4 mm
CM1218-02S7	SC70-3	2.05 X 1.25 X 0.95	2.40 X 2.40 X 1.19	8 mm	178 mm (7")	3000	4 mm	4 mm
CM1218-04S7	SC70-5	2.05 X 1.25 X 0.95	2.25 X 2.40 X 1.20	8 mm	178 mm (7")	3000	4 mm	4 mm
CM1218-05S7	SC70-6	2.05 X 1.25 X 0.95	2.25 X 2.40 X 1.20	8 mm	178 mm (7")	3000	4 mm	4 mm

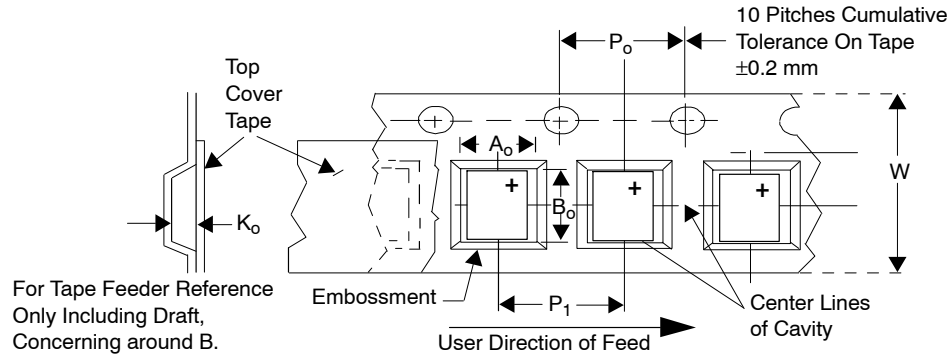

CM1218

PACKAGE DIMENSIONS

SOT-23 3-Lead (TO-236AA)
CASE 419AH-01
ISSUE O

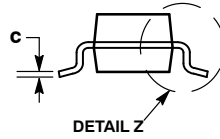
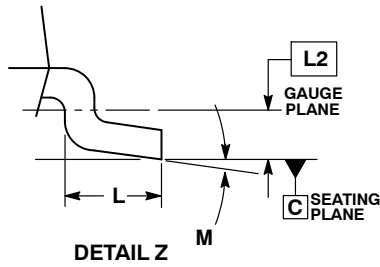
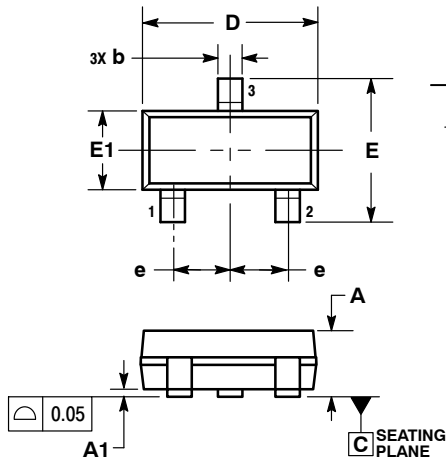

NOTES:

1. DIMENSIONING AND TOLERANCING PER ASME Y14.5M, 1994.
2. CONTROLLING DIMENSION: MILLIMETERS
3. MAXIMUM LEAD THICKNESS INCLUDES LEAD FINISH THICKNESS. MINIMUM LEAD THICKNESS IS THE MINIMUM THICKNESS OF BASE MATERIAL.
4. DIMENSIONS D AND E1 DO NOT INCLUDE MOLD FLASH, PROTRUSIONS, OR GATE BURRS. MOLD FLASH, PROTRUSIONS, OR GATE BURRS SHALL NOT EXCEED 0.15 PER SIDE. DIMENSIONS D AND E1 ARE DETERMINED AT DATUM H.
5. PIN ONE INDICATOR MUST BE LOCATED IN THE INDICATED ZONE.

DIM	MILLIMETERS	
	MIN	MAX
A	0.75	1.17
A1	0.05	0.15
b	0.30	0.50
c	0.08	0.20
D	2.80	3.05
E	2.10	2.64
E1	1.20	1.40
e	0.95 BSC	
L	0.40	0.60
L2	0.25 BSC	
M	0°	8°

RECOMMENDED SOLDERING FOOTPRINT*

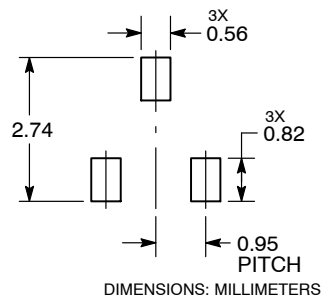

*For additional information on our Pb-Free strategy and soldering details, please download the ON Semiconductor Soldering and Mounting Techniques Reference Manual, SOLDERRM/D.

CM1218

PACKAGE DIMENSIONS

SOT-23, 5 Lead
CASE 527AH-01
ISSUE O

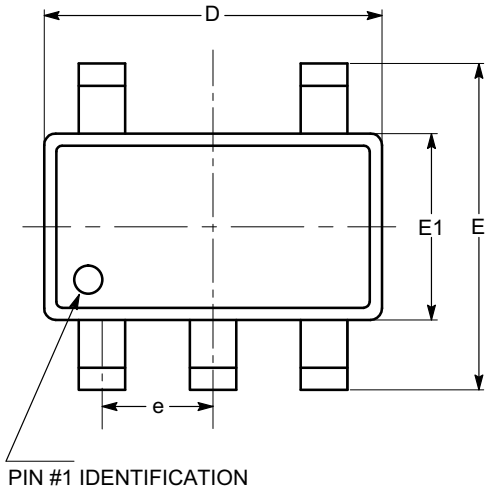

TOP VIEW

SYMBOL	MIN	NOM	MAX
A	0.90		1.45
A1	0.00		0.15
A2	0.90	1.15	1.30
b	0.30		0.50
c	0.08		0.22
D	2.90 BSC		
E	2.80 BSC		
E1	1.60 BSC		
e	0.95 BSC		
L	0.30	0.45	0.60
L1	0.60 REF		
L2	0.25 REF		
θ	0°	4°	8°
θ_1	5°	10°	15°
θ_2	5°	10°	15°

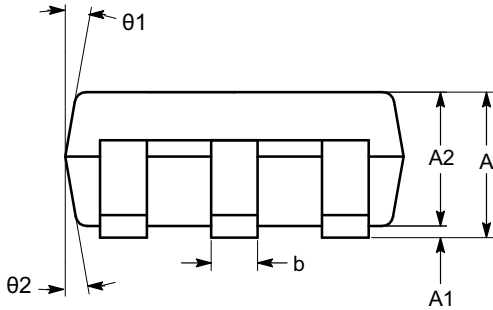

SIDE VIEW

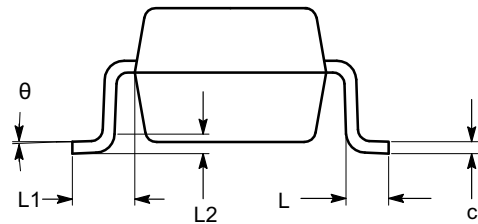

END VIEW

Notes:

- (1) All dimensions in millimeters. Angles in degrees.
- (2) Complies with JEDEC standard MO-178.

CM1218

PACKAGE DIMENSIONS

SOT-23, 6 Lead
CASE 527AJ-01
ISSUE A

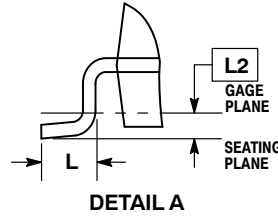
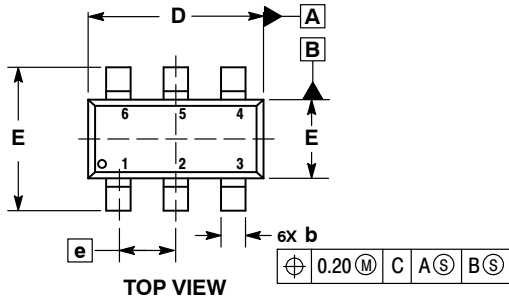

- NOTES:
1. DIMENSIONING AND TOLERANCING PER ASME Y14.5M, 1994.
 2. CONTROLLING DIMENSION: MILLIMETERS.
 3. DATUM C IS THE SEATING PLANE.

MILLIMETERS		
DIM	MIN	MAX
A	---	1.45
A1	0.00	0.15
A2	0.90	1.30
b	0.20	0.50
c	0.08	0.26
D	2.70	3.00
E	2.50	3.10
E1	1.30	1.80
e	0.95 BSC	
L	0.20	0.60
L2	0.25 BSC	

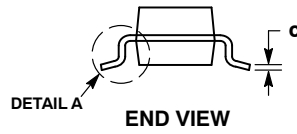
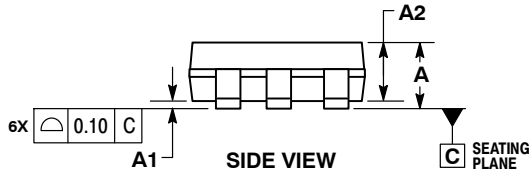

RECOMMENDED SOLDERING FOOTPRINT*

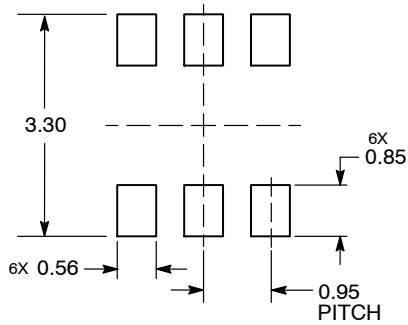

DIMENSIONS: MILLIMETERS

*For additional information on our Pb-Free strategy and soldering details, please download the ON Semiconductor Soldering and Mounting Techniques Reference Manual, SOLDERRM/D.

CM1218

PACKAGE DIMENSIONS

SOT-143, 4 Lead
CASE 527AF-01
ISSUE A

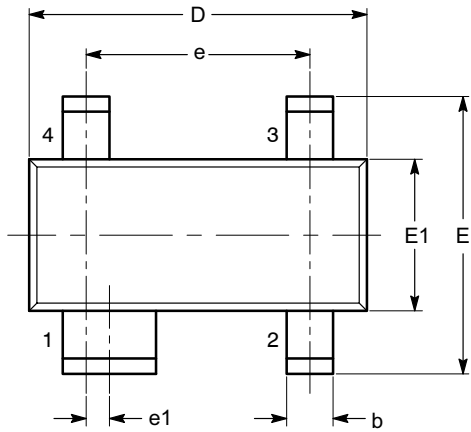

TOP VIEW

SYMBOL	MIN	NOM	MAX
A	0.80		1.22
A1	0.05		0.15
A2	0.75	0.90	1.07
b	0.30		0.50
b2	0.76		0.89
c	0.08		0.20
D	2.80	2.90	3.04
E	2.10		2.64
E1	1.20	1.30	1.40
e	1.92 BSC		
e1	0.20 BSC		
L	0.40	0.50	0.60
L1	0.54 REF		
L2		0.25	
θ	0°		8°

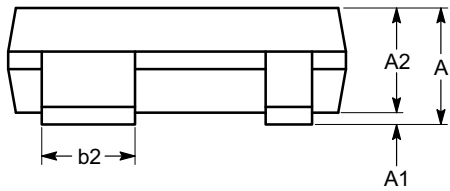

SIDE VIEW

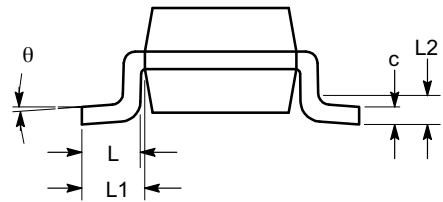

END VIEW

Notes:

- (1) All dimensions are in millimeters. Angles in degrees.
- (2) Complies with JEDEC TO-253.

CM1218

PACKAGE DIMENSIONS

SOT-553, 5 LEAD CASE 463B-01 ISSUE B

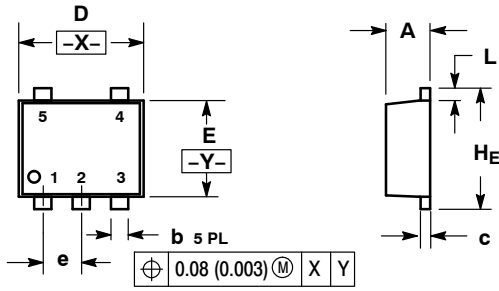

NOTES:

1. DIMENSIONING AND TOLERANCING PER ANSI Y14.5M, 1982.
2. CONTROLLING DIMENSION: MILLIMETERS
3. MAXIMUM LEAD THICKNESS INCLUDES LEAD FINISH THICKNESS. MINIMUM LEAD THICKNESS IS THE MINIMUM THICKNESS OF BASE MATERIAL.

DIM	MILLIMETERS			INCHES		
	MIN	NOM	MAX	MIN	NOM	MAX
A	0.50	0.55	0.60	0.020	0.022	0.024
b	0.17	0.22	0.27	0.007	0.009	0.011
c	0.08	0.13	0.18	0.003	0.005	0.007
D	1.50	1.60	1.70	0.059	0.063	0.067
E	1.10	1.20	1.30	0.043	0.047	0.051
e	0.50 BSC			0.020 BSC		
L	0.10	0.20	0.30	0.004	0.008	0.012
HE	1.50	1.60	1.70	0.059	0.063	0.067

SOLDERING FOOTPRINT*

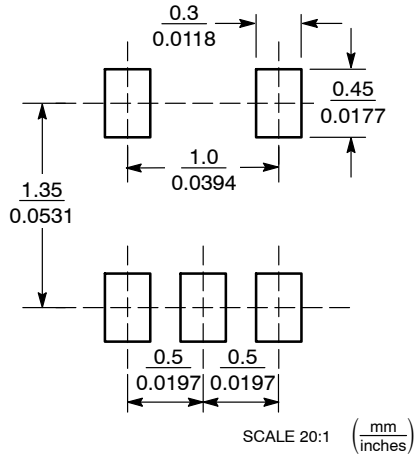

*For additional information on our Pb-Free strategy and soldering details, please download the ON Semiconductor Soldering and Mounting Techniques Reference Manual, SOLDERRM/D.

STYLE 2:

- PIN 1. CATHODE
2. COMMON ANODE
3. CATHODE 2
4. CATHODE 3
5. CATHODE 4

CM1218

PACKAGE DIMENSIONS

SOT-563, 6 LEAD
CASE 463A-01
ISSUE F

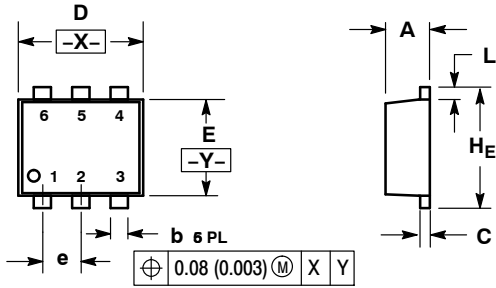

NOTES:

1. DIMENSIONING AND TOLERANCING PER ANSI Y14.5M, 1982.
2. CONTROLLING DIMENSION: MILLIMETERS
3. MAXIMUM LEAD THICKNESS INCLUDES LEAD FINISH THICKNESS. MINIMUM LEAD THICKNESS IS THE MINIMUM THICKNESS OF BASE MATERIAL.

DIM	MILLIMETERS			INCHES		
	MIN	NOM	MAX	MIN	NOM	MAX
A	0.50	0.55	0.60	0.020	0.021	0.023
b	0.17	0.22	0.27	0.007	0.009	0.011
C	0.08	0.12	0.18	0.003	0.005	0.007
D	1.50	1.60	1.70	0.059	0.062	0.066
E	1.10	1.20	1.30	0.043	0.047	0.051
e	0.5 BSC			0.02 BSC		
L	0.10	0.20	0.30	0.004	0.008	0.012
HE	1.50	1.60	1.70	0.059	0.062	0.066

STYLE 7:

- PIN 1. CATHODE
2. ANODE
3. CATHODE
4. CATHODE
5. ANODE
6. CATHODE

SOLDERING FOOTPRINT*

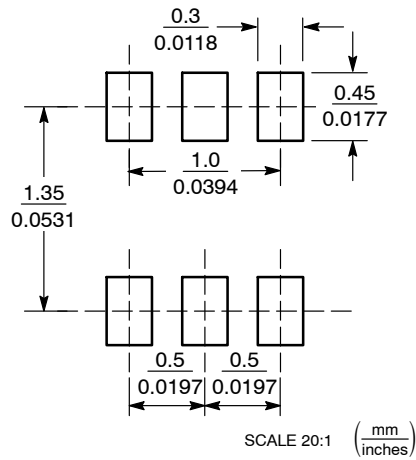

*For additional information on our Pb-Free strategy and soldering details, please download the ON Semiconductor Soldering and Mounting Techniques Reference Manual, SOLDERRM/D.

CM1218

PACKAGE DIMENSIONS

SC-70, 3 Lead, 1.25x2
CASE 419AB-01
ISSUE O

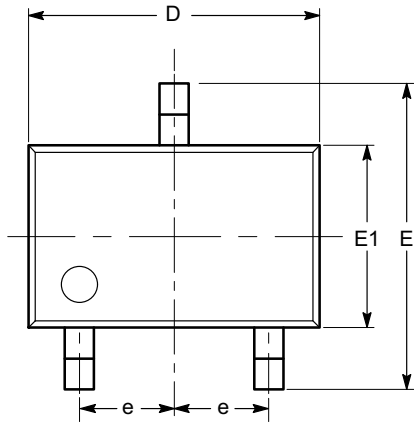

TOP VIEW

SYMBOL	MIN	NOM	MAX
A	0.80		1.10
A1	0.00		0.10
A2	0.80	0.90	1.00
b	0.15		0.30
c	0.08		0.22
D	1.80	2.00	2.20
E	1.80	2.10	2.40
E1	1.15	1.25	1.35
e	0.65 BSC		
L	0.26	0.36	0.46
L1	0.42 REF		
L2	0.15 BSC		
θ	0°		8°
$\theta 1$	4°		10°

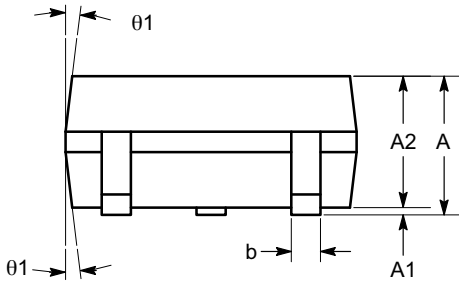

SIDE VIEW

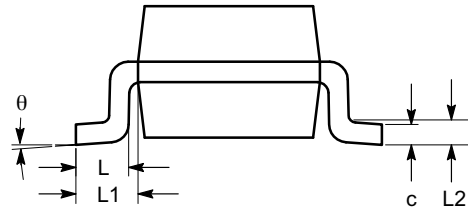

END VIEW

Notes:

- (1) All dimensions are in millimeters. Angles in degrees.
- (2) Complies with JEDEC MO-203.

CM1218

PACKAGE DIMENSIONS

SC-88A (SC-70 5 Lead), 1.25x2
 CASE 419AC-01
 ISSUE A

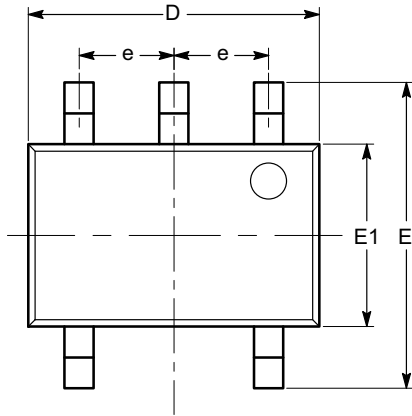

TOP VIEW

SYMBOL	MIN	NOM	MAX
A	0.80		1.10
A1	0.00		0.10
A2	0.80		1.00
b	0.15		0.30
c	0.10		0.18
D	1.80	2.00	2.20
E	1.80	2.10	2.40
E1	1.15	1.25	1.35
e	0.65 BSC		
L	0.26	0.36	0.46
L1	0.42 REF		
L2	0.15 BSC		
θ	0°		8°
$\theta 1$	4°		10°

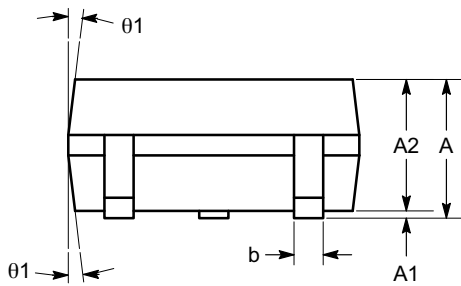

SIDE VIEW

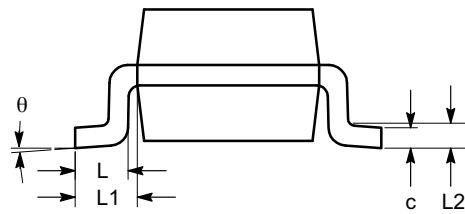

END VIEW

Notes:

- (1) All dimensions are in millimeters. Angles in degrees.
- (2) Complies with JEDEC MO-203.

CM1218

PACKAGE DIMENSIONS

SC-88 (SC-70 6 Lead), 1.25x2
CASE 419AD-01
ISSUE A

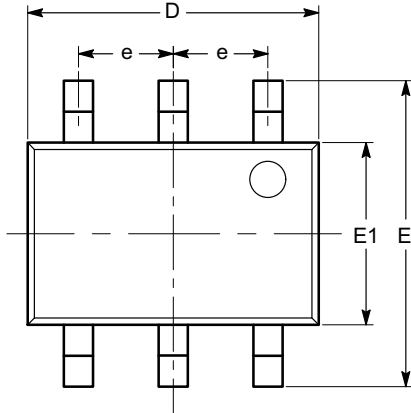

TOP VIEW

SYMBOL	MIN	NOM	MAX
A	0.80		1.10
A1	0.00		0.10
A2	0.80		1.00
b	0.15		0.30
c	0.10		0.18
D	1.80	2.00	2.20
E	1.80	2.10	2.40
E1	1.15	1.25	1.35
e	0.65 BSC		
L	0.26	0.36	0.46
L1	0.42 REF		
L2	0.15 BSC		
θ	0°		8°
$\theta1$	4°		10°

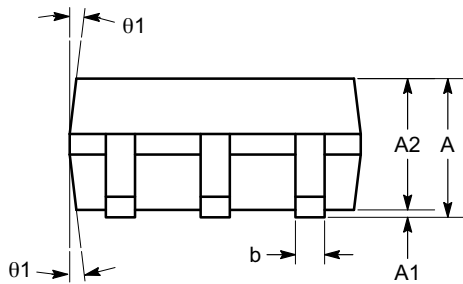

SIDE VIEW

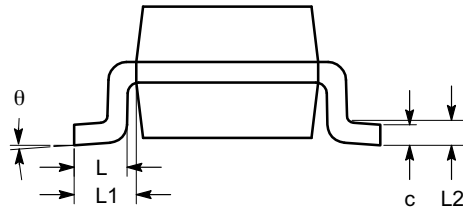

END VIEW

Notes:

- (1) All dimensions are in millimeters. Angles in degrees.
- (2) Complies with JEDEC MO-203.

CM1218

ORDERING INFORMATION

Device	Package	Shipping
CM1218-02SO	SOT23-3 (Pb-Free)	3000/Tape & Reel
CM1218-04SO	SOT23-5 (Pb-Free)	3000/Tape & Reel
CM1218-05SO	SOT23-6 (Pb-Free)	3000/Tape & Reel
CM1218-03SR	SOT-143 (Pb-Free)	3000/Tape & Reel
CM1218-04SE	SOT-553 (Pb-Free)	5000/Tape & Reel

ORDERING INFORMATION (cont'd)

Device	Package	Shipping
CM1218-05SE	SOT563 (Pb-Free)	5000/Tape & Reel
CM1218-F4SE	SOT563 (Pb-Free)	5000/Tape & Reel
CM1218-02S7	SC70-3 (Pb-Free)	3000/Tape & Reel
CM1218-04S7	SC70-5 (Pb-Free)	3000/Tape & Reel
CM1218-05S7	SC70-6 (Pb-Free)	3000/Tape & Reel

ON Semiconductor and  are registered trademarks of Semiconductor Components Industries, LLC (SCILLC). SCILLC reserves the right to make changes without further notice to any products herein. SCILLC makes no warranty, representation or guarantee regarding the suitability of its products for any particular purpose, nor does SCILLC assume any liability arising out of the application or use of any product or circuit, and specifically disclaims any and all liability, including without limitation special, consequential or incidental damages. "Typical" parameters which may be provided in SCILLC data sheets and/or specifications can and do vary in different applications and actual performance may vary over time. All operating parameters, including "Typicals" must be validated for each customer application by customer's technical experts. SCILLC does not convey any license under its patent rights nor the rights of others. SCILLC products are not designed, intended, or authorized for use as components in systems intended for surgical implant into the body, or other applications intended to support or sustain life, or for any other application in which the failure of the SCILLC product could create a situation where personal injury or death may occur. Should Buyer purchase or use SCILLC products for any such unintended or unauthorized application, Buyer shall indemnify and hold SCILLC and its officers, employees, subsidiaries, affiliates, and distributors harmless against all claims, costs, damages, and expenses, and reasonable attorney fees arising out of, directly or indirectly, any claim of personal injury or death associated with such unintended or unauthorized use, even if such claim alleges that SCILLC was negligent regarding the design or manufacture of the part. SCILLC is an Equal Opportunity/Affirmative Action Employer. This literature is subject to all applicable copyright laws and is not for resale in any manner.

PUBLICATION ORDERING INFORMATION

LITERATURE FULFILLMENT:

Literature Distribution Center for ON Semiconductor
P.O. Box 5163, Denver, Colorado 80217 USA
Phone: 303-675-2175 or 800-344-3860 Toll Free USA/Canada
Fax: 303-675-2176 or 800-344-3867 Toll Free USA/Canada
Email: orderlit@onsemi.com

N. American Technical Support: 800-282-9855 Toll Free
USA/Canada
Europe, Middle East and Africa Technical Support:
Phone: 421 33 790 2910
Japan Customer Focus Center
Phone: 81-3-5773-3850

ON Semiconductor Website: www.onsemi.com
Order Literature: <http://www.onsemi.com/orderlit>
For additional information, please contact your local
Sales Representative